

INSTALLATION GUIDE PANEL FOOT—SOLO MECH

FAILURE TO FOLLOW THESE INSTRUCTIONS COULD RESULT IN DAMAGE TO YOUR BED AND OR INJURY OR DEATH.

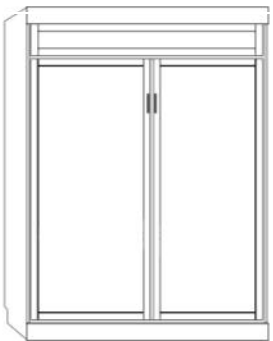

TOOLS NEEDED:

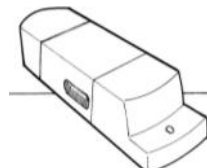

1/2" BOX END WRENCH PHILLIPS SCREWDRIVER CORDLESS DRILL STUD FINDER 6' LADDER

BOX #1-TRAY BOX



BAG HARDWARE BAG

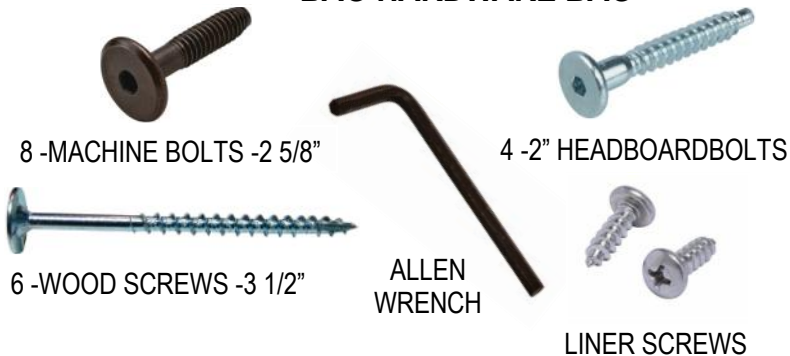

CABINET HARDWARE



CAN BE FOUND ON THE TOP OF ALL STORAGE PIER CABINETS. TO PREVENT TIP OVER HAZZARD, ATTACH ALL CABINETS INTO A WALL STUD THROUGH THE TOP



BOX #2-CABINET BOX



BASEBOARD NOTCH



Dark Edge= FINISHED EDGE



POSITION PARTS

LAY OUT COMPONENTS IN FRONT OF THE WALL YOU WILL INSTALL THE BED ON. AS SHOWN

1

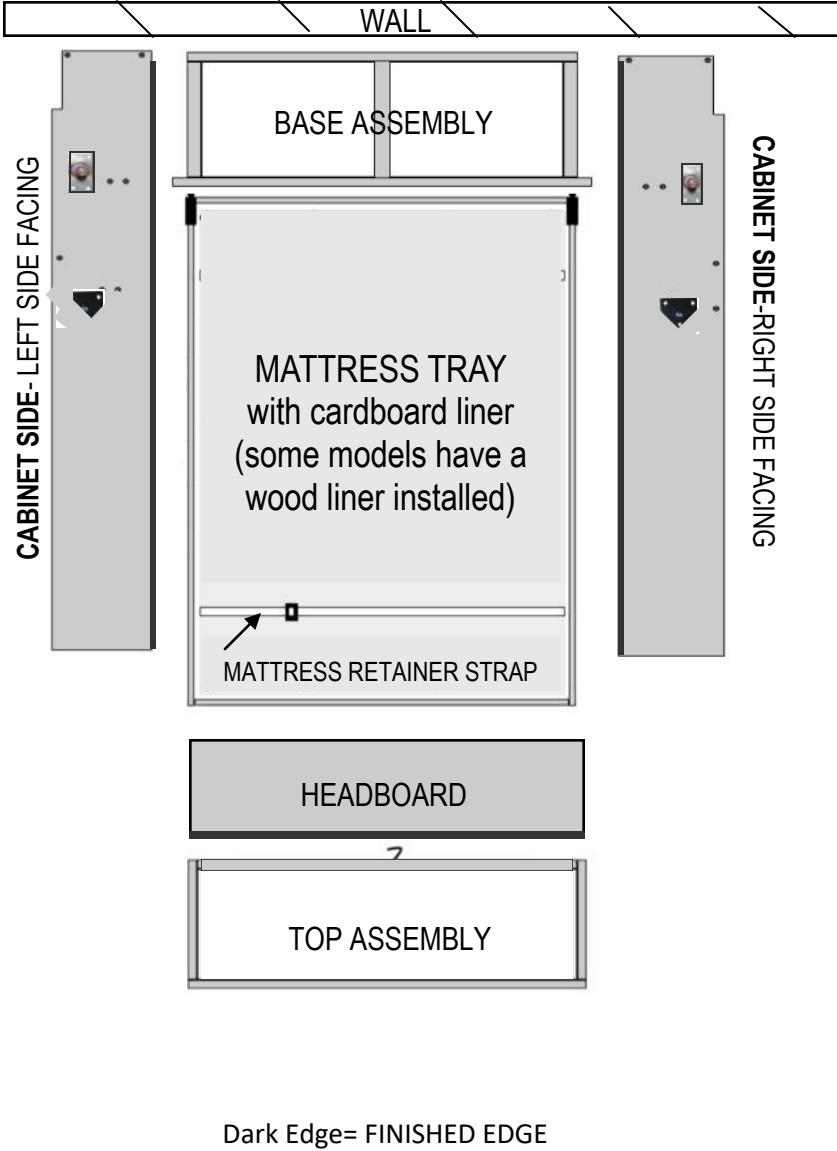

2

USING A STUD FINDER, MARK THREE STUDS IN THE WALL. BEHIND WHERE THE WALLBED WILL BE INSTALLED.

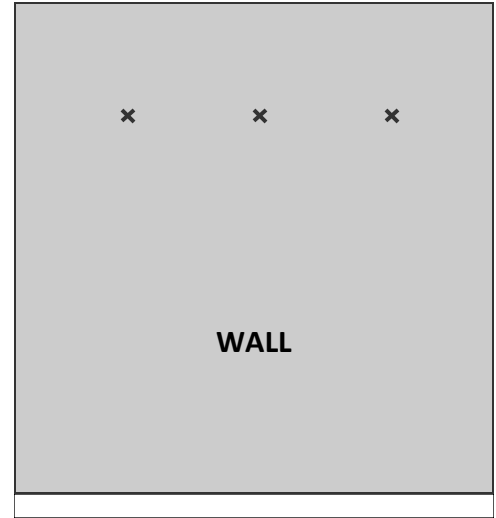
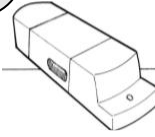

3

LAY TRAY ON THE FLOOR, FINISHED SIDE DOWN, WITH THE HEAD END AT LEAST 2' FROM THE WALL.

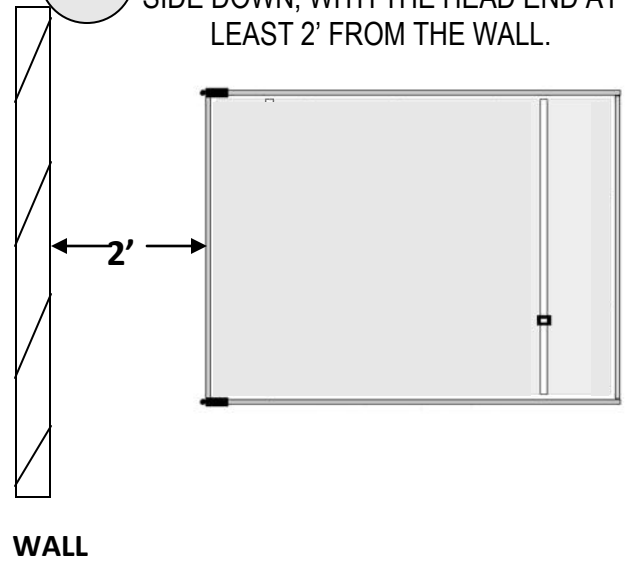

CABINET

WALL

PLACE CABINET SIDES FINISHED EDGE FACING THE FLOOR, NEXT TO THE TRAY, SO THAT THE PIVOT AXELS ON THE CABINET SIDES ARE NEAR THE PIVOT HOLE PLATES ON THE TRAY. SLIDE THE AXELS INTO THE HOLES AS SHOWN AT RIGHT.

4

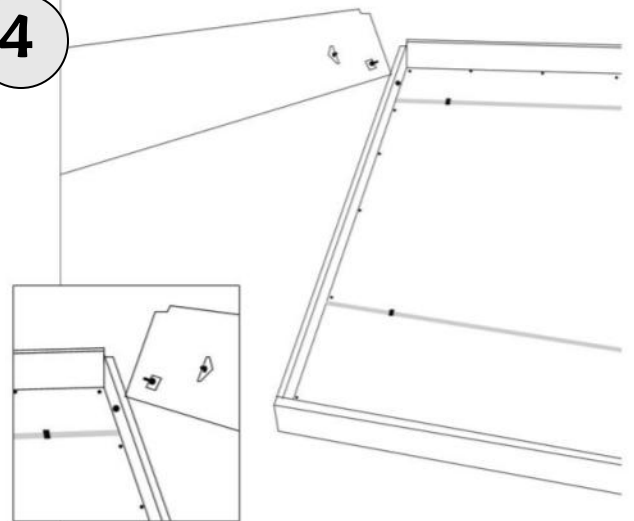

5

MOUNT THE PISTONS BY FIRST SNAPPING THE SHAFT END ONTO THE ADJUSTABLE BALL STUDS MOUNTED ON THE SIDE OF THE TRAY END. GRASP THE BARREL END OF THE PISTON AND ROTATE IT 180 DEGREES SO THE END SOCKET FACES THE BALL STUD ON THE TRIANGLE PLATE FOUND ON THE CABINET SIDE.

ONE PERSON SLOWLY LIFTS THE END OF THE MATTRESS TRAY ABOUT 4-6" UNTIL THE PISTON SOCKET LINES UP WITH THE BALL STUD FOUND ON THE CABINET SIDE. THE SECOND PERSON THEN SNAPS EACH PISTON ONTO THE BALL STUD FOUND ON THE CABINET SIDE. WHEN THE BALL AND PISTON END ARE LINED UP, THEY SNAP TOGETHER EASILY. **DO NOT HAMMER OR USE OTHER FORCE.**

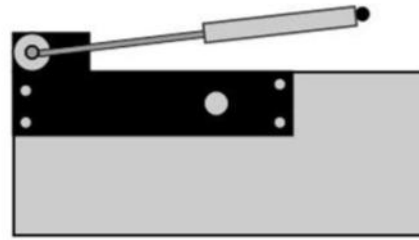
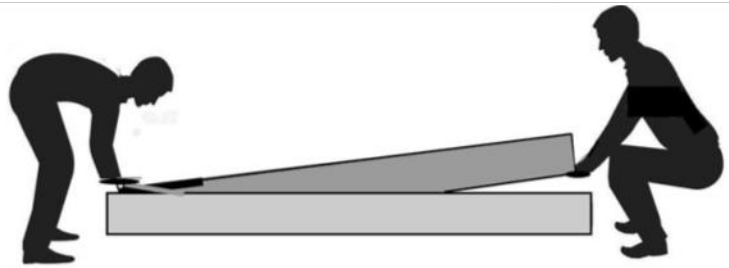

NEVER FORCE THE PISTON ONTO THE BALL STUD AS YOU MAY DAMAGE THE CLIP.

6

TOP ASSEMBLY PLACE THE CABINET TOP ASSEMBLY BETWEEN THE CABINET SIDES AT THE END AWAY FROM THE WALL. THE FINISHED EDGES FACING THE FLOOR AND THE TRAY. INSERT AND TIGHTEN 2 MACHINE BOLTS THROUGH THE HOLES INTO EACH SIDE OF THE TOP.



4 -MACHINE BOLTS -2 5/8"

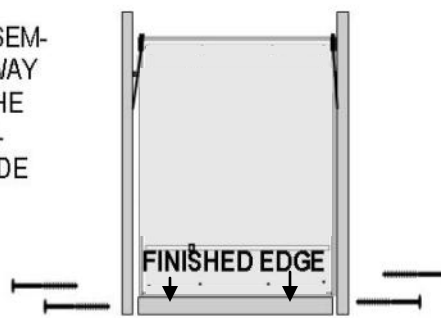

7

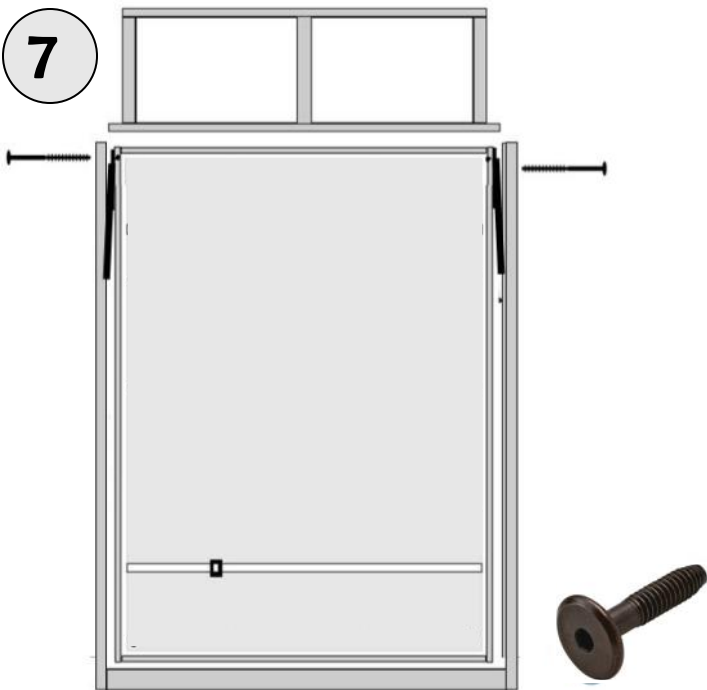

4-MACHINE BOLTS -2 5/8"

BASE ASSEMBLY ATTACH THE BASE FRAME BETWEEN THE SIDES AT THE END CLOSEST TO THE WALL. THE FINISHED EDGE SHOULD BE FACING THE FLOOR. THE TOP EDGE SHOULD BE FLUSH WITH THE BASE ASSEMBLY. SLIP MACHINE BOLTS IN THE PRE-BORED HOLES ON THE BACK EDGE OF THE SIDES NEAR THE PISTON JOINTS.

INSERT YOUR MATTRESS PLACE YOUR MATTRESS INSIDE THE TRAY AND SECURE IT BY BUCKLING BOTH RETAINER STRAPS AROUND THE MATTRESS.

www.wallbedscompany.com

8

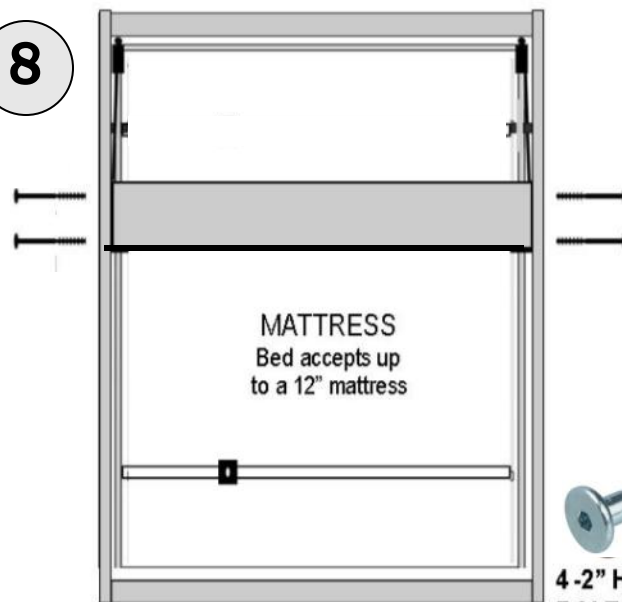

MATTRESS
Bed accepts up
to a 12" mattress



4 -2" HEADBOARD BOLTS

ATTACH THE HEADBOARD

LAY THE HEADBOARD ON THE BOLTS BETWEEN THE SIDES, WITH THE FINISHED SIDE FACING THE MATTRESS AND THE FINISHED EDGE FACING THE CABINET TOP. ATTACH THE PANEL AT EACH END BY LIFTING THE END, RETRACTING THE BOLTS, LETTING THE END DOWN IN POSITION, AND STARTING THE BOLTS IN TO THE PANEL ENDS. WHEN ALL THE BOLTS ARE STARTED, TIGHTEN FIRMLY WITH THE ALLEN WRENCH.

916-607-7728

9 ATTACH TO THE WALL

SLIP SOME CARDBOARD BETWEEN THE CABINET SIDES ABOUT 6' UP.

THESE SHIMS WILL KEEP THE BED SQUARELY ALIGNED AS YOU ATTACH IT TO THE WALL.

MARK 3 WALL STUDS

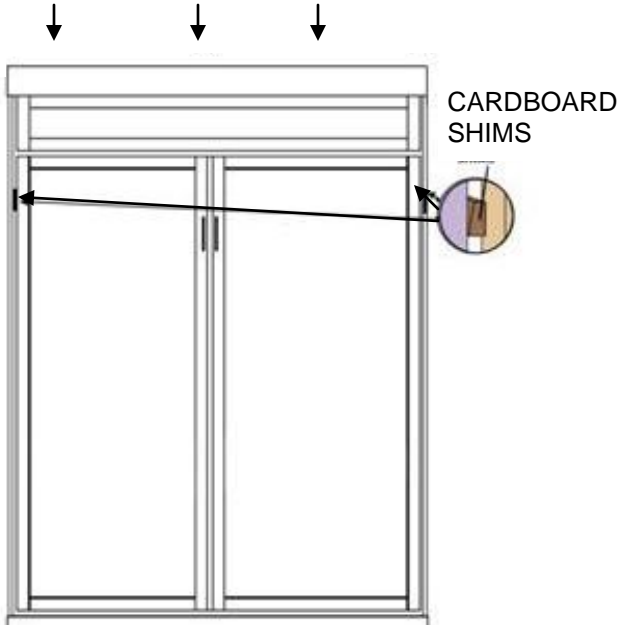

USING A STUD FINDER, LOCATE 3 WOOD WALL STUDS BEHIND THE BED AND MARK THEM WITH A VERTICAL LINE EXTENDING A FEW INCHES ABOVE AND BELOW THE CABINET TOP. WITH TWO PEOPLE TILT YOUR WALLBED INTO POSITION AGAINST THE WALL, MAKING SURE THAT ALL 3 STUD LINES ARE BETWEEN THE 2 SIDE PANELS. REACH OVER THE TOP OF THE UNIT AND DRIVE 6 -3 1/2" WOOD SCREWS THROUGH THE TOP ASSEMBLY BACK RAIL INTO THE WALL STUDS.



If you are working with sheet metal studs, cinder block, brick, or concrete, you must provide three anchor points of 100 pounds strength each, before installing a Wallbed!

!!! DO NOT ANCHOR TO SHEETROCK !!!

MAKE SURE THERE ARE NO PLUMBING PIPES IN THE AREA WHERE YOU ARE ATTACHING THE BED. CONSULT A LICENSED CONTRACTOR WITH ANY INSTALLATION CONCERNS

INSTALL THE SAFETY CABLE

LOCATED IN THE TOP OF YOUR BED. ATTACH ONE END OF THE SAFETY CABLE TO THE CABINET BACK RAIL WITH THE 3/4" SCREW PROVIDED. LEAVING ABOUT A 3" LOOP IN THE CABLE ATTACH THE WOOD SCREW INTO THE CLOSEST WALL STUD WITH THE 2" WASHER HEAD SCREW ABOUT 1" HIGHER THAN THE CABINET TOP. THE SCREW WHEN PROPERLY DRIVEN INTO THE WALL STUD SHOULD BE FAIRLY HARD TO DRIVE.

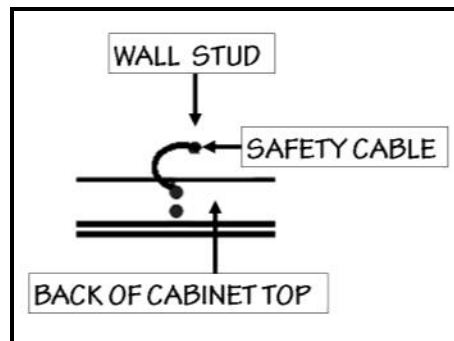

SAFETY CABLE-ATTACH CABLE TO CABINET TOP AND INTO WALL



THE FUNCTION OF THE SAFETY CABLE IS TO MAKE ATTACHMENT FAILURE OF THE BED VISABLE BY ALLOWING THE BED TO COME AWAY FROM THE WALL 2 TO 3 INCHES. WHEN YOU SEE THIS CONDITION DO NOT OPEN THE BED! YOU MUST INVESTIGATE WHAT IS WRONG AND CORRECT IT!

CHECK ALIGNMENT OF WALLBED

10 YOUR WALLBED SHOULD NOW BE IN LOCATION. VISUALLY CHECK THE ALIGNMENT OF THE MATTRESS TRAY AND CABINET BY LOOKING AT THE NARROW SPACE BETWEEN THE TRAY AND THE CABINET SIDES TO SEE THAT THE TRAY WILL NOT BE RUBBING EITHER SIDE PANEL. TO CORRECT ALIGNMENT, JUST NUDGE THE BASE OF THE CABINET SLIGHTLY TO EITHER SIDE. WHEN ALIGNMENT IS CORRECT HOLD THE BED OPEN, REACH IN UNDERNEATH AND DRIVE A 2 1/2" WOOD SCREW THROUGH THE BACK RAIL INTO THE WALL OR FLOOR, AS YOU CHOOSE. THIS WILL KEEP THE CABINET FROM SHIFTING OFFLINE

11 ATTACH DECORATIVE HANDLES

NOTE:SOME MODELS DO NOT HAVE DECORATIVE HANDLES.

ONCE YOU HAVE YOUR BED SECURELY FASTENED INTO 3 WALL STUDS YOU CAN OPEN THE BED. ONE PERSON HOLDS THE BED OPEN AS THE SECOND PERSON LIFTS THE CARDBOARD LINER TO SEE 4 HOLES FOR THE HANDLE SCREWS. INSERT THE HANDLE SCREWS TO ATTACH THE HANDLES ON THE FINISHED TRAY FRONT.

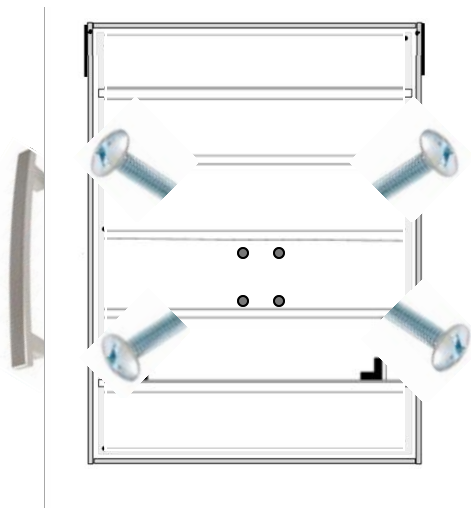

OPEN YOUR BED WHEN YOU LIFT UP THE FOOT PANEL ON THE FACE OF THE BED, YOU RELEASE A LATCHING MECHANISM WHICH NOW ALLOWS THE BED TO BE OPENED. BY SIMPLY GRASPING THE OPENING IN THE BED FACE REVEALED UNDER THE PANEL FOOT, YOU CAN USE YOUR BODY WEIGHT TO HELP THE BED OPEN VERY SLOWLY TOWARD THE FLOOR. ONCE PARTIALLY OPENED, THE BED WILL OPEN ALL THE WAY DOWN TO THE FLOOR.

CLOSE YOUR BED- REMOVE THE PILLOWS AND SECURE ALL LINENS INSIDE THE MATTRESS TRAY. LIFT THE BED UP TO ABOUT WAIST LEVEL, THEN TAKE HOLD OF THE OPENING UNDER THE PANEL FOOT, SO YOU MAINTAIN CONTROL OF THE BED WHILE IT CLOSSES. CONTINUE CLOSING THE BED UNTIL THE BED IS CLOSED. LOWER THE PANEL FOOT TO LATCH THE BED.



NEVER FORCE YOUR WALLBED OPEN AS DAMAGE MAY RESULT!

SOMETHING (BEDDING, MATTRESS, PILLOWS) IS LIKELY WEDGED INSIDE CAUSING THE BED TO NOT OPEN. **STOP, INVESTIGATE AND CORRECT ANY OBSTRUCTION.** FORCING THE OPERATION CAN RESULT IN BREAKING THE TRAY STRUCTURE OR MECHANISM, LEADING TO POSSIBLE INJURY OR EXPENSIVE REPAIRS.

13 ATTACHING CABINETS

IF YOU ADDED SIDE STORAGE PIER CABINETS THEY ALSO MUST BE SECURELY FASTENED INTO A WALL STUD.

ON THE TOP OF YOUR CABINET YOU WILL FIND A 3 1/2" LONG WOOD SCREW. LOCATE THE CLOSEST WALL STUD AND DRIVE THE SCREW THROUGH THE CABINET BACK INTO THE STUD.



TIP OVER HAZZARD

WOOD SCREWS -3 1/2"



ALL STORAGE PIER TOWERS MUST BE SECURELY FASTENED INTO A WALL STUD THROUGH THE TOP. FAILURE TO DO SO COULD RESULT IN INJURY OR DEATH.



TROUBLESHOOTING GUIDE

BED WON'T STAY DOWN– MATTRESS MUST BE INSTALLED FOR THE BED TO OPERATE PROPERLY.YOUR MATTRESS MAY BE TOO LIGHT. YOU MAY ADD WEIGHT WITH WOOD OR PARTICLE BOARD TO THE FOOT AREA UNDER THE LINER BOARD.

EASY ALIGNMENT– IF THE SIDE PANELS BOW OUT, YOU MAY HAVE OVERTORQUED THE ASSEMBLY BOLTS AT THE TOP. TRY BACKING THEM A BIT TO SEE IF THE BOW RELAXES. THE SAME TRICK CAN BE EFFECTIVE WITH THE HEADBOARD BOLTS.

IF THE LATCH DOESN'T ENGAGE WELL, IT IS LIKELY THAT THE CABINET TOP ASSEMBLY NEEDS TO BE ADJUSTED A BIT DOWNWARD. JUST LOOSEN THE TOP ASSEMBLY BOLTS AND NUDGE THE ASSEMBLY DOWN, THEN RETIGHTEN.

SQUEAKS CAN DEVELOP WITH BEDS INSTALLED OVER CARPET. THEY OCCUR BECAUSE OF RUBBING BETWEEN SURFACES AS THE BED FLEXES ON THE CARPET. IF YOU RUN INTO THIS RARE SIUTUATION, YOU CAN CORRECT THE PROBLEM BY SHIMMING THE BASE MOLDING FROM THE SIDE BY LOOSENING THE ASSEMBLY BOLTS, INSERTING A SMALL SHIM BETWEEN THE BASE AND SIDE THEN RETIGHTEN THE BOLTS.

ODOR-WE MANUFACTURE IN CALIFORNIA UNDER THE STRICTEST ENVIRONMENTAL LAWS IN THE NATION. AS WITH ALL NEW FURNITURE, WHEN YOU OPEN THE CARTONS, YOU MAY NOTICE AN ODOR THAT WILL DISSIPATE WITH TIME.

PERIODICALLY INSPECT YOUR WALLBED. USING A LADDER, INSPECT THE CABINET TOP TO ENSURE THE BED IS STILL SECURLY FASTENED INTO 3 STUDS. VERIFY THAT THE SAFETY CABLE IS INSTALLED AND OPERATIONAL. CHECK TO SEE THAT THE MATTRESS IS STILL SECURELY BUCKLED INSIDE THE MATTRESS TRAY. CHECK THAT ALL OF THE BOLTS ARE STILL TIGHT.

MOVING THE FULLY ASSEMBLED WALLBED IS NOT RECOMMENDED. WHEN YOU DO DECIDE TO MOVE YOUR WALLBED, SIMPLY FOLLOW THESE DIRECTIONS IN REVERSE.

NEVER DETACH YOUR BED FROM THE WALL UNLESS IT IS CLOSED AND LATCHED IN THE UPRIGHT POSITION.

NEVER TRY TO REMOVE THE PISTONS WHEN THE BED IS OPEN AS THEY CAN SHOOT TO FULL EXTENSION WITH GREAT FORCE WHICH CAN CAUSE SERIOUS INJURY. PISTONS CAN ONLY BE REMOVED WHEN THE BED HAS BEEN DISMOUNTED FROM THE WALL AND THE PISTONS ARE IN THEIR FULLY EXTENDED POSITION, WITH THE BED CLOSED. WITH THE BED OFF THE WALL AND LYING ON THE FLOOR IN THE CLOSED POSITION, BACK THE ADJUSTABLE BALLS TO RELIEVE THE PISTONS OF TENSION. INSERT A SLOTHEAD SCREWDRIVER UNDER THE SPRING BAND ON THE BACK OF THE PISTON HEADS AND TWIST THE SCREWDRIVER GENTLY TO RELIEVE THE CONNECTION. IF YOU PULL AWAY FROM THE BALL WHILE TWISTING, THE PISTON WILL COME OFF EASILY.

CARE –BIRCH IS A DURABLE AND TIMELESS HARDWOOD THAT EXPANDS AND CONTRACTS WITH CHANGES IN HUMIDITY AND MAY COLOR OVER TIME AS IT'S EXPOSED TO AIR, SUNLIGHT AND WEAR. OUR VENEERS IN COMBINATION WITH SOLID WOOD GIVES GREATER STABILITY WHILE REDUCING EXPANSION AND CONTRACTION DUE TO HUMIDITY. COLOR, GRAIN AND MARKINGS WILL VARY WITH EACH PIECE. OUR LACQUER IS A CLEAR, LOW SHEEN FINISH THAT SEALS AND HELPS PROTECT SURFACES, WHILE HIGHLIGHTING THAT NATURAL BEAUTY OF REAL WOOD. LACQUER IS FORMULATED TO HOLD UP WELL TO DAILY USE BUT TAKE CARE TO AVOID DIRECT HEAT. TO CARE FOR YOUR FURNITURE-JUST WIPE WITH A SOFT DAMP CLOTH AND THEN DRY THE SURFACE IMMEDIATELY. ALL WOOD IS SUSCEPTIBLE TO SCRATCHES AND DINGS SO USE COASTERS AND PADS TO PROTECT YOUR FURNITURE.

MADE USA
IN THE